

Pecyn Dogfen Gyhoeddus

Gareth Owens LL.B Barrister/Bargyfreithiwr
Chief Officer (Governance)
Prif Swyddog (Llywodraethu)



At: Cyng David Wisinger (Cadeirydd)

CS/NG

Cynghorwyr: Mike Allport, Bernie Attridge,
Chris Bithell, Derek Butler, Ian Dunbar,
Veronica Gay, Gladys Healey, Patrick Heesom,
Paul Johnson, Christine Jones, Richard Jones,
Richard Lloyd, Mike Peers, Neville Phillips and
Owen Thomas

Dydd Iau, 25 Mawrth 2021

Maureen Potter 01352 702322
maureen.potter@flintshire.gov.uk

Annwyl Syr / Fadam

RHYBUDD O GYFARFOD ANGHYSBELL
PWYLLGOR CYNLLUNIO
DYDD MERCHER, 31 MAWRTH, 2021 am **1.00 PM**

Mae'r rhaglen hon yn destun cyfyngiadau o ran cynnwys oherwydd Cyfnod yr Etholiad sy'n dechrau ar Dydd Llun 22 Mawrth ac yn dod i ben ar Dydd Sul 9 Mai 2021.

Yn ddiffuant,

Robert Robins
Rheolwr Gwasanaethau Democraidd

Sylwch: Bydd hwn yn gyfarfod dros y we a bydd 'presenoldeb' wedi'i gyfyngu i Aelodau'r Pwyllgor a'r Aelodau hynny o'r Cyngor sydd wedi gofyn i Bennaeth y Gwasanaethau Democraidd am wahoddiad. Y Cadeirydd fydd yn penderfynu a yw'r rhain yn cael siarad ai peidio.

Bydd y cyfarfod yn cael ei ffrydio'n fyw ar wefan y Cyngor. Bydd recordiad o'r cyfarfod ar gael yn fuan ar ôl y cyfarfod ar <https://flintshire.publici.tv/core/portal/home>

Os oes gennych unrhyw ymholiadau, cysylltwch ag aelod o'r Tîm Gwasanaethau Democraidd ar 01352 702345.

Cyfarfod Anghysbell y Pwyllgor Cynllunio – Cyfranogiad y Cyhoedd

Ni all aelodau'r cyhoedd, gwrthwynebwy'r na chefnogwyr y ceisiadau gyfarch y pwyllgor anghysbell. Gofynnir am eu safbwyntiau cyn y cyfarfod a bydd eu datganiadau'n cael eu cynnwys o fewn pecyn adroddiad y Pwyllgor.

R H A G L E N

1 YMDDIHEURIADAU

2 DATGAN CYSYLLTIAD

3 SYLWADAU HWYR

4 COFNODION (Tudalennau 5 - 8)

I gadarnhau, fel cofnod cywir gofnodion y cyfarfod ar 3 Mawrth 2021.

5 EITEMAU I'W GOHIRIO

6 ADRODDIAD Y PRIF SWYDDOG (CYNLLUNIO, AMGYLCHEDD AC ECONOMI)

Mae adroddiad y Prif Swyddog (Cynllunio, Amgylchedd ac Economi) yn amgaeedig.

ADRODDIAD Y PRIF SWYDDOG (CYNLLUNIO, AMGYLCHEDD AC ECONOMI) AR GYFER Y PYLLGOR CYNLLUNIO 31 MAWRTH 2021

| Rhif yr eitem | Cyfeirnod y Ffeil | DISGRIFIAD |
|--|-------------------|---|
| <u>Ceisiadau sy'n cael eu hadrodd er penderfyniad (A= adroddiad er cymeradwyaeth, R= adroddiad er gwrthodiad)</u> | | |
| 6.1 | 061148 – A | Newid defnydd o Ganolfan Cymuned ac Ieuenctid Bistre, yn cynnwys hen adeilad yr ysgol a maes parcio, i ddefndd cymysg fel caffï, ysgol fecws, cylch chwarae/meithrinfa, neuadd chwaraeon aml ddefnydd, cyfleuster hyfforddi/academia chwaraeon gyda neuadd chwaraeon dan do allanol a lle parcio cysylltiedig yng Nghanolfan Gymuned Bistre, Ffordd Nant Mawr, Bwcle. (Tudalennau 9 - 28) |
| 6.2 | 061974 – R | Cadw annedd preswyl fel y cafodd ei adeiladu a chwblhau annedd yn Fferm Pen Uchaf, Ffordd Pen y Cefn, Caerwys. (Tudalennau 29 - 50) |

Sylwch y gall fod 10 munud o egwyl yn y cyfarfod hwn os yw'n para fwy na dwy awr

Nodyn Gweithdrefnol ar redeg cyfarfodydd

Bydd y Cadeirydd yn agor y cyfarfodydd ac yn cyflwyno eu hunain.

Bydd nifer o Gynghorwyr yn mynychu cyfarfodydd. Bydd swyddogion hefyd yn mynychu cyfarfodydd i gyflwyno adroddiadau, gyda swyddogion Gwasanaethau Democrataidd yn trefnu a chynnal y cyfarfodydd.

Gofynnir i bawb sy'n mynychu i sicrhau bod eu ffonau symudol wedi diffodd a bod unrhyw sain gefndirol yn cael ei gadw mor dawel â phosib.

Dylai'r holl feicroffonau gael eu rhoi "ar miwt" yn ystod y cyfarfod a dim ond pan fyddwch yn cael eich gwahodd i siarad gan y Cadeirydd y dylid eu rhoi ymlaen. Pan fydd gwahoddedigion wedi gorffen siarad dylen nhw roi eu hunain yn ôl "ar miwt".

Er mwyn mynegi eu bod nhw eisiau siarad bydd Cynghorwyr yn defnyddio'r cyfleuster 'chat' neu yn defnyddio'r swyddogaeth 'raise hand' sy'n dangos eicon codi llaw electronig. Mae'r swyddogaeth 'chat' hefyd yn gallu cael ei ddefnyddio i ofyn cwestiynau, i wneud sylwadau perthnasol ac yn gyfle i'r swyddog gynghori neu ddiweddarau'r cynghorwyr.

Bydd y Cadeirydd yn galw ar y siaradwyr, gan gyfeirio at aelod etholedig fel 'Cynghorydd' a swyddogion yn ôl eu teitl swydd h.y. Prif Weithredwr neu enw. O bryd i'w gilydd mae'r swyddog sy'n cynghori'r Cadeirydd yn egluro pwyntiau gweithdrefnol neu'n awgrymu geiriad arall ar gyfer cynigion er mwyn cynorthwyo'r Pwyllgor.

Os, a phan y cynhelir pleidlais, mi fydd y Cadeirydd yn egluro mai dim ond y rheiny sy'n gwrthwynebu'r cynnig/cynigion, neu sy'n dymuno ymatal a fydd angen mynegi hynny drwy ddefnyddio'r swyddogaeth 'chat'. Bydd y swyddog sy'n cynghori'r Cadeirydd yn mynegi os bydd y cynigion yn cael eu derbyn.

Os oes angen pleidlais fwy ffurfiol, bydd hynny yn ôl galwad enwau – lle gofynnir i bob Cynghorydd yn ei dro (yn nhrefn yr wyddor) sut mae ef / hi yn dymuno pleidleisio.

Yng nghyfarfodydd Pwyllgorau Cynllunio a Chyngor Sir mae amseroedd siaradwyr yn gyfyngedig. Bydd cloch yn cael ei chanu i roi gwybod i'r siaradwyr bod ganddyn nhw funud ar ôl.

Bydd y cyfarfod yn cael ei ffrydio'n fyw ar wefan y Cyngor. Bydd recordiad o'r cyfarfod ar gael yn fuan ar ôl y cyfarfod ar <https://flintshire.public-i.tv/core/portal/home>

Mae'r dudalen hon yn wag yn bwrpasol

Eitem ar gyfer y Rhaglen 4

PLANNING COMMITTEE **3 MARCH 2021**

Minutes of the meeting of the Planning Committee of Flintshire County Council held as a remote attendance meeting on Wednesday, 3 March 2021

PRESENT: Councillor David Wisinger (Chairman)

Councillors: Mike Allport, Chris Bithell, Derek Butler, Ian Dunbar, Veronica Gay, Gladys Healey, Patrick Heesom, Paul Johnson, Christine Jones, Richard Jones, Richard Lloyd, Mike Peers, Neville Phillips and Owen Thomas

ALSO PRESENT:

Councillors Ian Roberts and Haydn Bateman attended as observers
Jonathan Duggan-Keen (Independent member of the Standards Committee) attended as an observer

IN ATTENDANCE:

Chief Officer (Planning, Environment & Economy), Development Manager, Service Manager - Strategy, Team Leader - Planning, Planning Officers, Senior Engineer - Highways Development Control, Legal Services Manager, Team Leader - Democratic Services and Democratic Services Officers

20. DECLARATIONS OF INTEREST

On Agenda item 6.3 (061530), Councillor Allport advised that whilst he did not have an interest, as local Member he had made clear his objections to the application. As a Member of the Committee, he would therefore remain at the meeting but would not speak or vote on the item.

On the same item, Councillor Richard Lloyd declared a personal interest as he had delivered coal to a property close to the site.

On Agenda item 6.4 (061817), Councillors Chris Bithell, Mike Peers and Owen Thomas advised that they had been contacted on more than three occasions by local residents, but not the applicant.

21. LATE OBSERVATIONS

The Chairman allowed Members an opportunity to read the late observations which had been circulated prior to the meeting and were appended to the agenda on the Flintshire County Council website:

<https://committeemeetings.flintshire.gov.uk/ieListDocuments.aspx?CId=490&MId=4856&LLL=0>

22. MINUTES

The minutes of the meeting on 13 January 2021 were confirmed as a correct record, as moved and seconded by Councillors Chris Bithell and Gladys Healey.

RESOLVED:

That the minutes be approved as a true and correct record.

23. ITEMS TO BE DEFERRED

No items were recommended for deferral.

24. REPORTS OF THE CHIEF OFFICER (PLANNING, ENVIRONMENT & ECONOMY)

RESOLVED:

That decisions be recorded as shown on the Planning Application schedule attached as an appendix.

25. MEMBERS OF THE PUBLIC AND PRESS IN ATTENDANCE

On commencement of the meeting, there was one member of the press in attendance.

(The meeting started at 1.00pm and ended at 3.35pm)

.....
Chairman

Meetings of the Planning Committee are webcast and can be viewed by visiting the webcast library at: <http://flintshire.public-i.tv/core/portal/home>

PLANNING COMMITTEE ON 3 MARCH 2021

| ITEM NO | TOWN/ COMMUNITY COUNCIL | SITE/PROPOSAL | THIRD PARTY / LOCAL MEMBER OBSERVATIONS | RESOLUTION |
|---------|-------------------------------|--|---|---|
| 061618 | Buckley Town Council | Change of use from former bank (A2) to residential development (C3) and conversion of building to six apartments at former 'Lloyds TSB Bank Plc', 2 Mold Road, Buckley | A statement of objection from the local Member, Councillor Carol Ellis, was appended to the report on the agenda. | That planning permission be granted subject to the applicant entering into a Section 106 Obligation or up-front payment of £733 per apartment in lieu of on-site public open space provision, the off-site contribution being used to enhance existing public open space in the community, namely Higher Common Play Area. Also subject to the conditions set out in the report, in accordance with the officer recommendation. |
| 061454 | Shotton Town Council | Change of Use from Use Class C3 (Residential Dwelling) to a House of Multiple Occupation at 110 Chester Road East, Shotton | A statement of support from the applicant was appended to the report on the agenda. A statement of objection from the local Member, Councillor Ron Davies, was appended to the report on the agenda. | That planning permission be granted subject to the conditions set out in the report, in accordance with the officer recommendation. |

Tudalen

| ITEM NO | TOWN/ COMMUNITY COUNCIL | SITE/PROPOSAL | THIRD PARTY / LOCAL MEMBER OBSERVATIONS | RESOLUTION |
|---------|--|---|---|---|
| 061530 | Higher Kinnerton Community Council | Residential development of 95 dwellings (including affordable housing), means of access, open space and all associated works at land adjacent to Higher Kinnerton Meadows, Kinnerton Lane, Higher Kinnerton | <p>A statement of objection from the Local Member, Councillor Mike Allport, was appended to the report on the agenda. He did not speak or vote on the item.</p> <p>A statement of objection from a local resident was appended to the report on the agenda.</p> | That planning permission be refused in accordance with the officer recommendation. |
| 61817 | Buckley Town Council | Flat roof to rear extension replacing a previously approved pitched roof at 17 Overleigh Drive, Buckley | <p>A statement of support from the applicant was appended to the report on the agenda.</p> <p>A statement of objection from the local Member, Councillor Carol Ellis, was appended to the report on the agenda.</p> <p>A statement of objection from a local resident was appended to the report on the agenda.</p> | That planning permission be granted subject to the conditions set out in the report, in accordance with the officer recommendation, with an additional condition to install obscured glazing in three windows on the gable end of the property. |

Eitem ar gyfer y Rhaglen 6.1

FLINTSHIRE COUNTY COUNCIL

REPORT TO: **PLANNING COMMITTEE**

DATE: **31st MARCH 2021**

REPORT BY: **CHIEF OFFICER (PLANNING, ENVIRONMENT AND ECONOMY)**

SUBJECT: **FULL APPLICATION- CHANGE OF USE FROM BISTRE YOUTH AND COMMUNITY CENTRE, COMPRISING FORMER SCHOOL BUILDING AND CAR PARKING TO MIXED USE AS CAFÉ, BAKERY SCHOOL, PLAYGROUP/NURSERY, MIXED USE SPORTS HALL, SPORTS TRAINING FACILITY/ACADEMY WITH EXTERNAL COVERED SPORTS HALL AND ASSOCIATED ADDITIONAL CAR PARKING**

APPLICATION NUMBER: **061148**

APPLICANT: **MR MARK JONES**

SITE: **BISTRE COMMUNITY CENTRE, NANT MAWR ROAD, BUCKLEY CH7 2PX**

APPLICATION VALID DATE: **2ND APRIL 2020**

LOCAL MEMBERS: **COUNCILLOR N PHILLIPS**
COUNCILLOR A WILLIAMS

TOWN/COMMUNITY COUNCIL: **BUCKLEY TOWN COUNCIL**

REASON FOR COMMITTEE: **MEMBER REQUEST**
IMPACT UPON NEIGHBOURING AMENITY

SITE VISIT: **YES**
CONCERNS OVER IMPACT OF SPORTS HALL ON EXISTING NEIGHBOUR AMENITY

1.00 SUMMARY

- 1.01 This is a full application for the change of use of the former bistre youth and community centre, comprising former school building and car parking, to a mixed use as cafe, bakery school, playgroup/nursery, mixed use sports hall, sports training

facility/academy as well as the erection of an external covered sports hall with associated additional car parking.

2.00 RECOMMENDATION: TO GRANT PLANNING PERMISSION, SUBJECT TO THE FOLLOWING:-

- 2.01
1. Time Limit
 2. Approved Plans
 3. Materials
 4. Use of suitable acoustic materials for sports hall as recommended in NIA
 5. Landscape plan
 6. Landscape plan implementation
 7. Hours of use
 8. Levels
 9. Restrictions to lighting
 10. Any doors or windows in sports hall to be closed whilst in use
 11. Once Sports hall no longer required, building removed and site returned to previous condition
 12. Foul water drainage scheme to be submitted
 13. No surface water to be allowed to connect directly or indirectly to the public sewerage network

3.00 CONSULTATIONS

3.01 Local Member

Councillor N Phillips

Concerns over covered sports hall- siting, noise, hours of use- requests committee determination.

Councillor A Williams

Feels that given nature of application it would be more suitable for Committee to determine application. Requests committee determination.

Buckley Town Council

No response at time of writing.

Highways Development Control

The proposals use the existing access to the site; the layout and available visibility splays are considered appropriate. No highways conditions are proposed.

Community and Business Protection

I have no objections to this proposal providing the following conditions are imposed to minimise adverse noise to nearby residential properties :-

1. The sports hall is not to be used after 21.00 hrs.
2. The sports hall is to be constructed of suitable acoustic materials as outlined in the applicants noise assessment with a minimum Sound Reduction Index of -25 dBA.

Welsh Water Dwr Cymru

Requests conditions.

Coal Authority

No objection.

4.00 PUBLICITY

4.01 Neighbour Notification

13 Objections received on the following grounds:

- Temporary sports hall- concern over its visual impact, noise and lighting intrusion
- General concerns over lighting overspill
- Smells from bakery
- Traffic impact- increased traffic flow to site and existing on street parking issues locally
- Security- anti social behaviour
- Proposed path on site- loss of privacy and security concerns from adjoining residents
- Opening hours
- Question of need for more sporting facilities- impact on other local centres
- Inadequacy of existing tarmac for car parking
- Site is not disused
- Land drainage issues
- Loss of existing trees/shrubs

3 Letters of Support

- Good to see building in reuse
- Additional parking will help local issues
- Community hub

5.00 SITE HISTORY

5.01 No relevant site history.

6.00 PLANNING POLICIES

- 6.01 Flintshire Unitary Development Plan
Policy STR1 – New Development
Policy STR11 – Sport, Leisure and Recreation
Policy GEN1 – General Requirements for Development
Policy GEN2 – Development Inside Settlement Boundaries
Policy D1- Design Quality, Location and Layout
Policy D2 – Design
Policy AC13 – Access and Traffic Impact
Policy AC18 – Parking Provision and New Development
Policy SR1 – Sports, Recreation or Cultural Facilities
Policy SR2 – Outdoor Activities

Planning Policy Wales edition 11

7.00 PLANNING APPRAISAL

7.01 Proposal

- 7.02 The proposal is for the change of use of the Bistre youth and community centre, to a mixed use as a cafe, micro bakery, playgroup/nursery, mixed use sports hall, sports training facility/academy with the erection of an external covered sports hall and associated additional car parking.

7.03 Site

- 7.04 The site is 0.89 hectares in area and is known as the Bistre Community Centre, Nant Mawr Road, Buckley, Flintshire within the settlement of Buckley in the Flintshire Unitary Development Plan. The site was a former primary school, prior to its use as a community centre. The site lies within a residential area and next to the Bistre Scout hut. The proposal utilises the entire site, including both the former school building and its playing fields to the side.

- 7.05 The site currently has a variety of community uses, including use as a nursery, day centre and as a venue for Slimming World meetings, although these uses only utilise a portion of the school building.

7.06 Principle of Development

- 7.07 The proposal is for a range of uses occupying the existing building but also proposing a new building, namely a covered sports hall. In principle there is no objection to the range of uses proposed or the formation of a sports facility within the settlement boundary of the town, having regard to the sites existing use and its location. I consider that the principle of the use as a sports and recreational

facility is in accordance with policies STR11 and SR1 of the Flintshire Unitary Development Plan.

- 7.08 The acceptability of the proposal is also subject to the proposal being an appropriate form of development which is sympathetic to the character of the site and its surroundings. As the site is in proximity to existing properties in particular those which back onto the site at Eglwys Close the safeguarding and the privacy and living conditions of the occupiers of these properties is a material consideration.
- 7.09 Paragraph 4.4.1 of Planning Policy Wales 11 stresses the importance of community facilities and how these can *“perform various functions which cover a broad range of activities and services and can be delivered by the public, private and third sectors’ Community facilities contribute to a sense of place which is important to the health, well being and amenity of local communities.”* Furthermore in paragraphs 4.5.1- 4.5.2 the importance of recreational sports facilities is emphasised, and it is stated that Planning Authorities should be promoting and supporting such developments.
- 7.10 **Proposed New Sports Hall**
- 7.11 The proposed sports hall is approximately 20x 30 metres and is approximately 7. 2m high to its highest point. In the context of the site and its topography I do not consider that this is a scale that is inappropriate for this location. This height is comparable to existing housing, which is also located on a higher point than the application site in the case of the two storey detached dwellings on Ffordd Eglwys. It is located between the former school building and the adjacent Scout Hut and can be read in the context of these buildings. These are both relatively large buildings in the context of the surroundings.
- 7.12 The sports hall has been sited in a position to ensure it is located as far away from existing residential properties as it can be, whilst relating to the facilities in the former school building, and the parking areas.
- 7.13 The proposed sports hall will provide a different form of training facility than is available in the local area. Objections have been raised which consider that the development is inappropriate given the residential nature of the locality. Whilst the site is surrounded by residential properties it should be noted that the site itself is not a residential site but has a long established educational and community use. The adjacent Scout hut has an analogous community and recreational use. The proposed sports hall is a pre-fabricated form of development. Its external colour can be conditioned to ensure that it is suitable for use in this location and

with regard to the amenity of residential properties. In order to protect the site and its amenity required a condition is proposed requiring its removal and the reinstatement of the land, if the use of this facility should no longer be required.

7.14 Living conditions of existing residents in relation to the New Sports Hall

7.15 The sports hall/training centre is proposed to the north of the dwelling known as 'Mizpah'. At its closest point the proposed sports hall is 21 metres from the rear of the dwelling known as Mizpah, which is the nearest residential property to the development. There are no windows in the sports hall and the impact will be from the bulk of the building.

7.16 It should be noted that the proposed sports hall is located further away from this property than the Scout Hut which is next to both sites. In addition the sports hall is not excessively tall, and there is a tall established hedgerow on the boundary between Mizpah and the application site which mitigates against much of the impact which will provide year round screening from the sports hall.

7.17 I have suggested a condition requiring a landscape plan and I would require any approved landscaping scheme to retain this feature. Policy D1 of the Flintshire Unitary Development Plan requires that development respects the scale of surrounding development, as well as relating well to the local topography and aspect of the site.

7.18 I consider that the proposal accords with this policy, as well as to GEN1 which requires that all development should harmonise with the site and its surroundings in terms of its siting, scale, layout and use of space, and that the sports hall is sited appropriately and with full regard to neighbouring living conditions.

7.19 There is approximately between 26, at its closest point, and 36 metres from the proposed sports hall to the rear of the nearest boundaries of the properties on Ffordd Eglwys. The boundary to the north of the site has an existing native species hedgerow and will be subject to the same landscape condition as above. It should also be noted that the dwellings abutting the site also have 1.8 metre high close boarded fences on their rear boundaries.

7.20 There is no prescribed distance between such forms of development and residential properties, although the existing living conditions of residential properties in the vicinity of the proposal must be given significant weight.

7.21 I consider that with regard to the living conditions of the occupiers of the dwellings on the northern boundary of the site the proposal is in accordance with the relevant policies within the Unitary

Development Plan, in that the sports hall is located in the most suitable location in order to protect existing living conditions whilst still be appropriate to its proposed use.

- 7.22 Given the proximity of residential properties to the site, concerns over harm to general noise and disturbance has been raised, particularly as a result of noise and light pollution. It should be noted that the hall will have 40mm insulated walls to protect against noise pollution.
- 7.23 The application has been supported by a Noise Impact Assessment, the findings of which have been reviewed by the Community and Business Protection service. One of the recommendations in the Noise Impact Assessment is that the sports hall will be constructed from appropriate materials, which will aid with noise dampening. It would be appropriate to condition this to ensure that the facility is suitable for its location and would not give rise to unacceptable impacts upon neighbouring living conditions. Furthermore a condition will be imposed to require all openings remained closed whilst the sports centre is in use.
- 7.24 The facility will shut at 9pm, and there are no high level flood lights proposed. In order to protect neighbouring residential living conditions a restrictive condition is proposed to prohibit external lighting in the parts of the site likely to have a potential conflict with neighbouring amenity.
- 7.25 **Change of Use of the Existing School Building**
- 7.26 The former school building is proposed to house both a café, which can be used for community purposes as well as by users of the sports facilities and parents waiting for their children's sports training sessions to end, as well as a Bakery school. These uses utilise currently unused areas of the building, and the existing tenants, a youth and community centre and day nursery, are unaffected by the proposal.
- 7.27 The main section of the school building is to be a community café, this includes a kitchen area and toilet facilities. Rooms to the west of the building are to be used as a microbakery with associated offices. In the north western part of the building there are to be areas for sports changing and other associated office and briefing uses.
- 7.28 These uses are considered to be appropriate to the building and the location in general and it is not considered that these will unacceptably impact upon neighbouring living conditions, as the uses are contained within the existing building. Third parties have raised issues regarding smells from the bakery school however the community and business protection service have raised no issue regarding the proposal. This matter is therefore attributed very

minor weight as it is considered that the bakery use would not be intensive and therefore would not generate smells which would unreasonably affect nearby occupiers.

7.29 New security doors are to be installed. I do not consider that this is inappropriate on this building.

8.00 **Other Matters**

8.01 Highway concerns, related to parking provision, were raised in response to the pre-application consultation however following discussions, the applicant has produced a Car Park Study. This study considers the parking demand for the current uses of the site in combination with those of the additional uses. A conservative approach has been taken which includes all cars stopping for a minimum of one hour where in reality a number of vehicles will simply drop off/pick up and disappear. Parking accumulation figures are anticipated to be below those values reported in the study.

8.02 The study suggests an existing provision of 40 spaces whereas the current layout (un-marked bays) is likely to accommodate less than this; the area in front of the building has insufficient depth to accommodate two parking bays with adequate maneuvering space between. The additional parking provision is however considered satisfactory to cater for additional demand.

8.03 In response to the publication of this planning application third parties have raised issues regarding security and anti-social behavior. There is no evidence to support that the proposed use will give rise to an increase in anti-social behavior and therefore this matter attracts very minor weight in the overall planning balance.

8.04 Further issue were raised questioning the need for the sporting facilities and that this facility may negatively impact on the use of other such facilities. There is no policy requirement for the applicant to demonstrate need for the sports centre or no policy which seeks to limit the number of sports facilities in order to protect existing facilities. This matter therefore attracts very minor weight in the overall planning balance.

8.05 Furthermore issues were raised about drainage. The site is already developed with drainage infrastructure which was suitable to serve a fully occupied school on a daily basis. The use proposed would utilise the existing drainage system which would be more than sufficient to accommodate the demands of the new and existing uses. This matter therefore attracts very minor weight in the overall planning balance.

9.00 **CONCLUSION**

The proposal is considered to be appropriate for the location and in accordance with relevant development plan and national policies. I consider that the proposal has adequately considered the impact of the proposal on neighbouring amenity and has taken steps to ensure that any impacts are minimised. The conditions proposed will further ensure that existing amenity is protected. The proposal represents a community and sports facility that will contribute positively to the local community and local place making, in line with the advice in Planning Policy Wales 11. As such I recommend accordingly.

8.01 Other Considerations

The Council has had due regard to its duty under Section 17 of the Crime and Disorder Act 1998 and considered that there would be no significant or unacceptable increase in crime and disorder as a result of the recommended decision.

The Council has acted in accordance with the Human Rights Act 1998 including Article 8 of the Convention and in a manner which is necessary in a democratic society in furtherance of the legitimate aims of the Act and the Convention.

The Council has had due regard to its public sector equality duty under the Equality Act 2010.

The Council has had due regard to its duty under Section 3 of the Wellbeing of Future Generations (Wales) Act 2015 and considered that there would be no significant or unacceptable impact upon the achievement of wellbeing objectives as a result of the recommended decision.



LIST OF BACKGROUND DOCUMENTS

Planning Application & Supporting Documents
National & Local Planning Policy
Responses to Consultation
Responses to Publicity

Contact Officer: James Beattie
Telephone: (01352) 703262
Email: james.beattie@flintshire.gov.uk

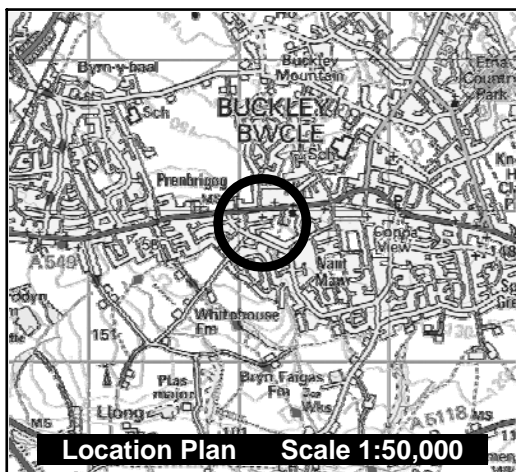
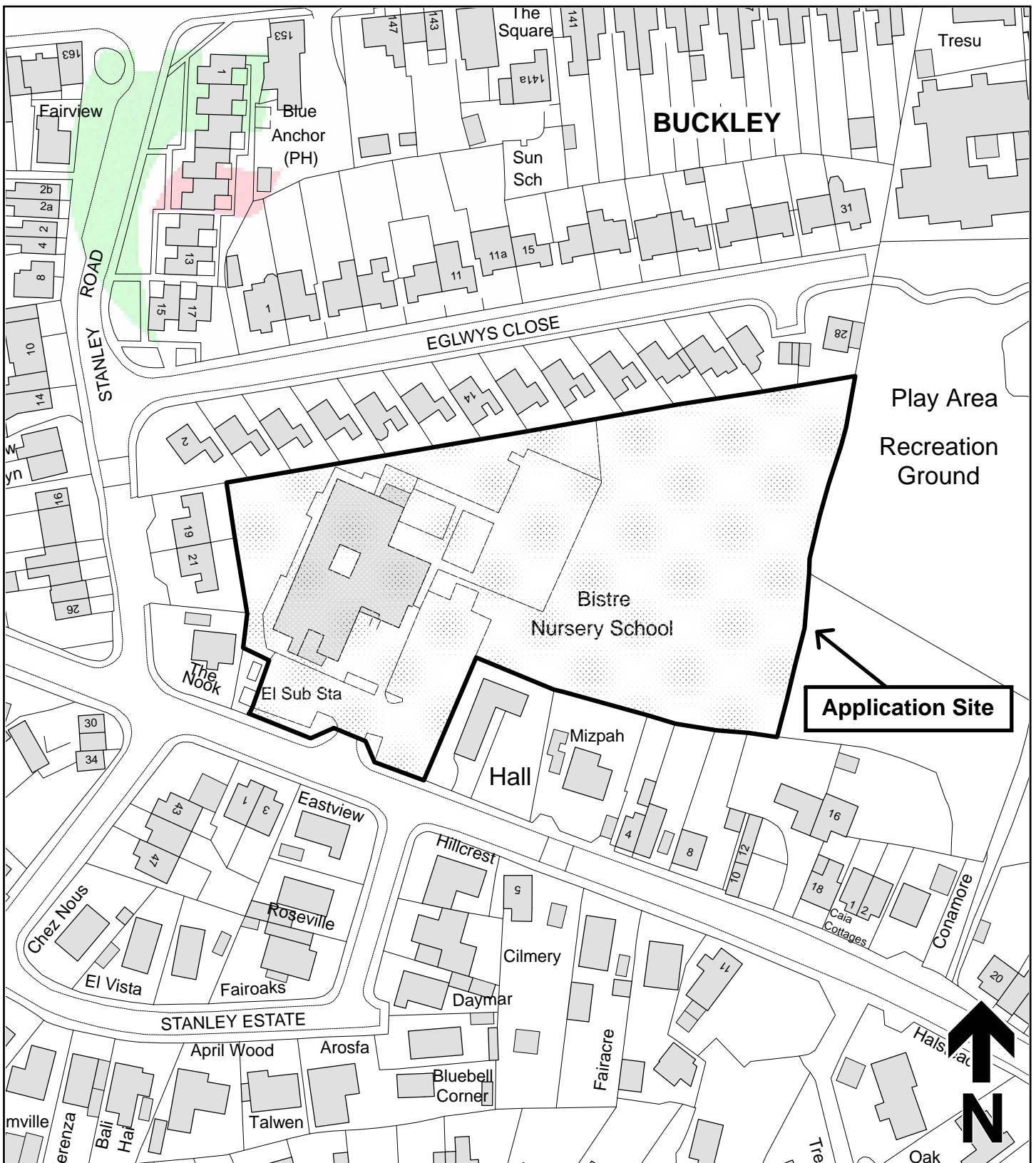
Mae'r dudalen hon yn wag yn bwrpasol



| | | | | | | | |
|---|---|---|-----------|--------|------------|---------|----------------------|
|  | Planning, Environment & Economy, Flintshire County Council, County Hall, Mold, Flintshire, CH7 6NF. Chief Officer: Mr Andrew Farrow | | | | | | |
| | <p>Legend</p> <ul style="list-style-type: none">  Planning Application Site  Adopted Flintshire Unitary Development Plan Settlement Boundary | <p>This plan is based on Ordnance Survey Material with the permission of the Controller of Her Majesty's Stationery Office. © Crown Copyright. Unauthorised reproduction infringes Crown Copyright and may lead to prosecution or civil proceedings. Licence number: 100023386. Flintshire County Council, 2020.</p> <table border="1"> <tr> <td>Map Scale</td> <td>1:1250</td> </tr> <tr> <td>OS Map ref</td> <td>SJ 2763</td> </tr> <tr> <td>Planning Application</td> <td>61148</td> </tr> </table> | Map Scale | 1:1250 | OS Map ref | SJ 2763 | Planning Application |
| Map Scale | 1:1250 | | | | | | |
| OS Map ref | SJ 2763 | | | | | | |
| Planning Application | 61148 | | | | | | |

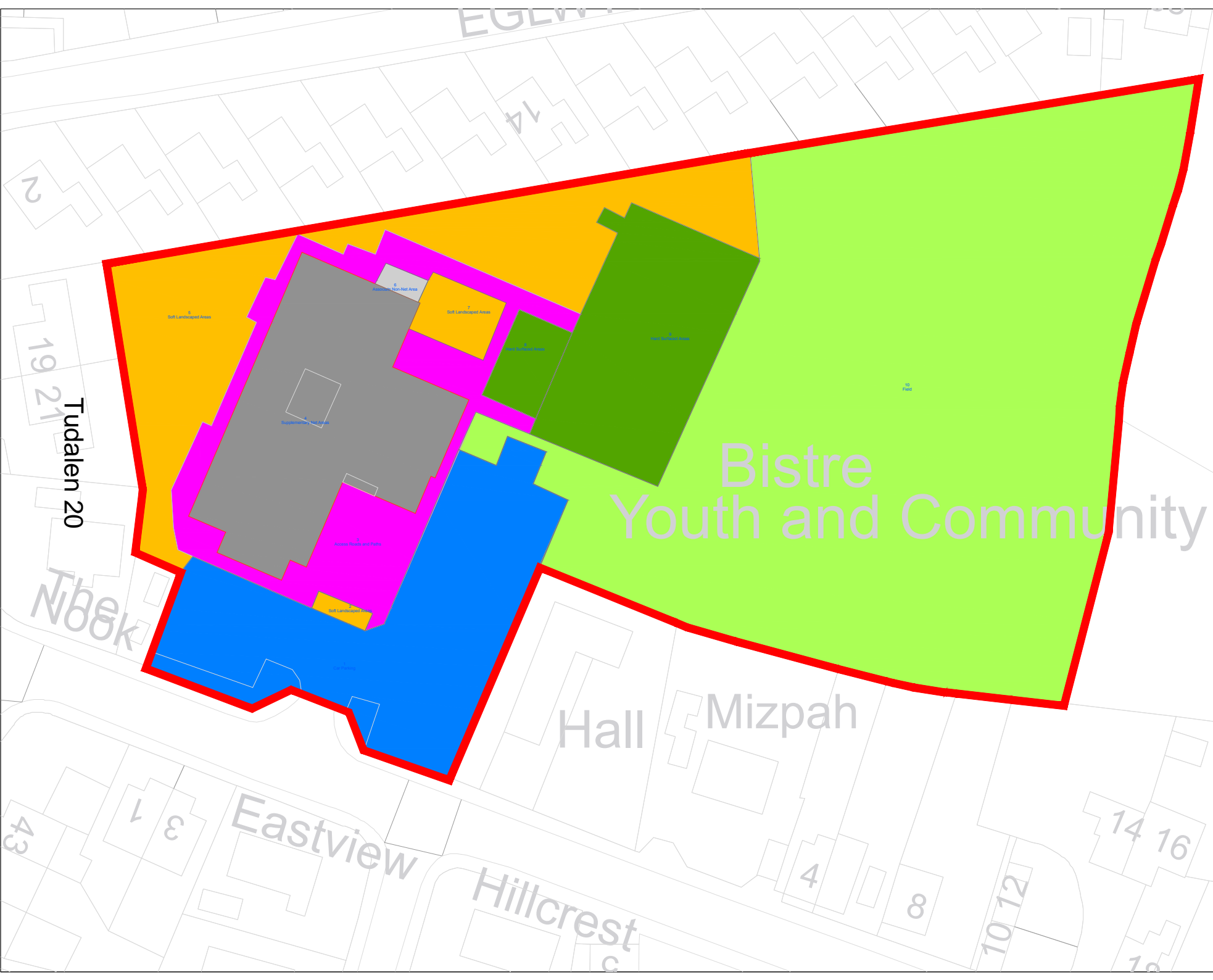

Bistre Youth and Community



- Playing Field
- Hard Surfaced Playing Areas
- Soft Landscaped Areas
- Access Roads and Paths
- Car Parking
- Habitat Areas
- Supplementary Net Area
- Associated Non-Net Area
- Access

| Source Type | Actual | |
|-----------------------------|-----------|----------------|
| | No. | m ² |
| Playing Field | 1 | 4611.68 |
| Hard Surfaced Playing Areas | 2 | 794.14 |
| Soft Landscaped Areas | 3 | 1138.69 |
| Access Roads and Paths | 1 | 168.21 |
| Car Parking | 1 | 1056.83 |
| Habitat | 0 | 0.0 |
| Supplementary Net Area | 1 | 892.73 |
| Associated Non-Net Area | 1 | 19.40 |
| Access | 0 | 0 |
| TOTAL | 10 | 8928.14 |

REF - Bistre youth and community centre - existing
 Drawn by M Jones
 Scale 1:200
 Date 3rd March 2020

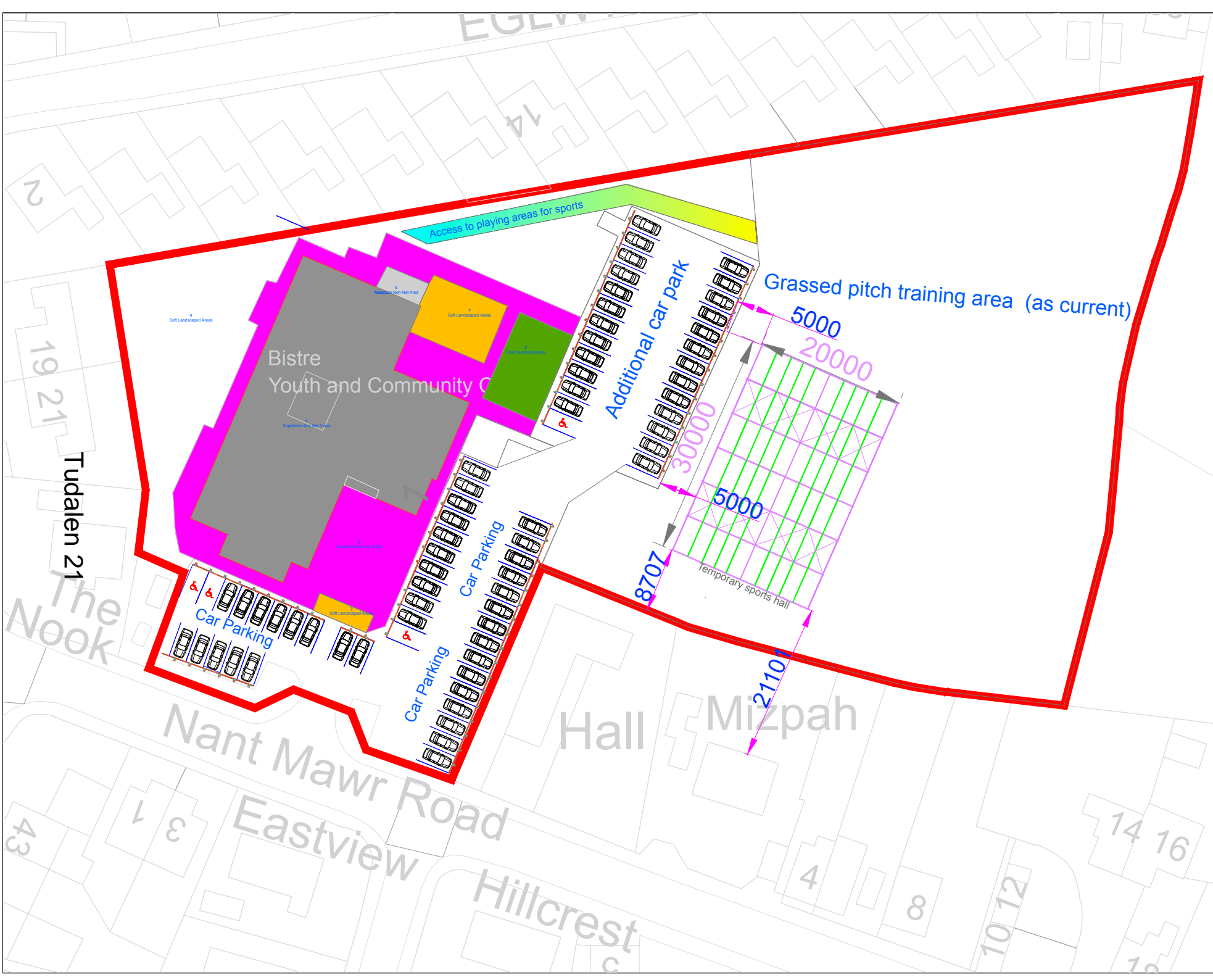

- Playing Field
- Hard Surfaced Playing Areas
- Soft Landscaped Areas
- Access Roads and Paths
- Car Parking
- Habitat Areas
- Supplementary Net Area
- Associated Non-Net Area
- Temporary sports hall

| Space Type | Actual | |
|-------------------------|--------|----------------|
| | Nb. | m ² |
| Playing Field | 1 | 9915.58 |
| Outdoor car parking | 2 | 734.14 |
| Soft landscaped Areas | 1 | 1128.99 |
| Access Roads and Paths | 1 | 938.07 |
| Car Parking | 1 | 1034.03 |
| Habitat | 0 | 0.00 |
| Supplementary Net Area | 1 | 869.73 |
| Associated Non-Net Area | 1 | 164.48 |
| Temporary sports hall | 1 | 900.00 |
| TOTAL | 10 | 8628.14 |

- Drawn by Mark Jones
- Date 2ND MARCH 2020
- Ref FINAL POS S H

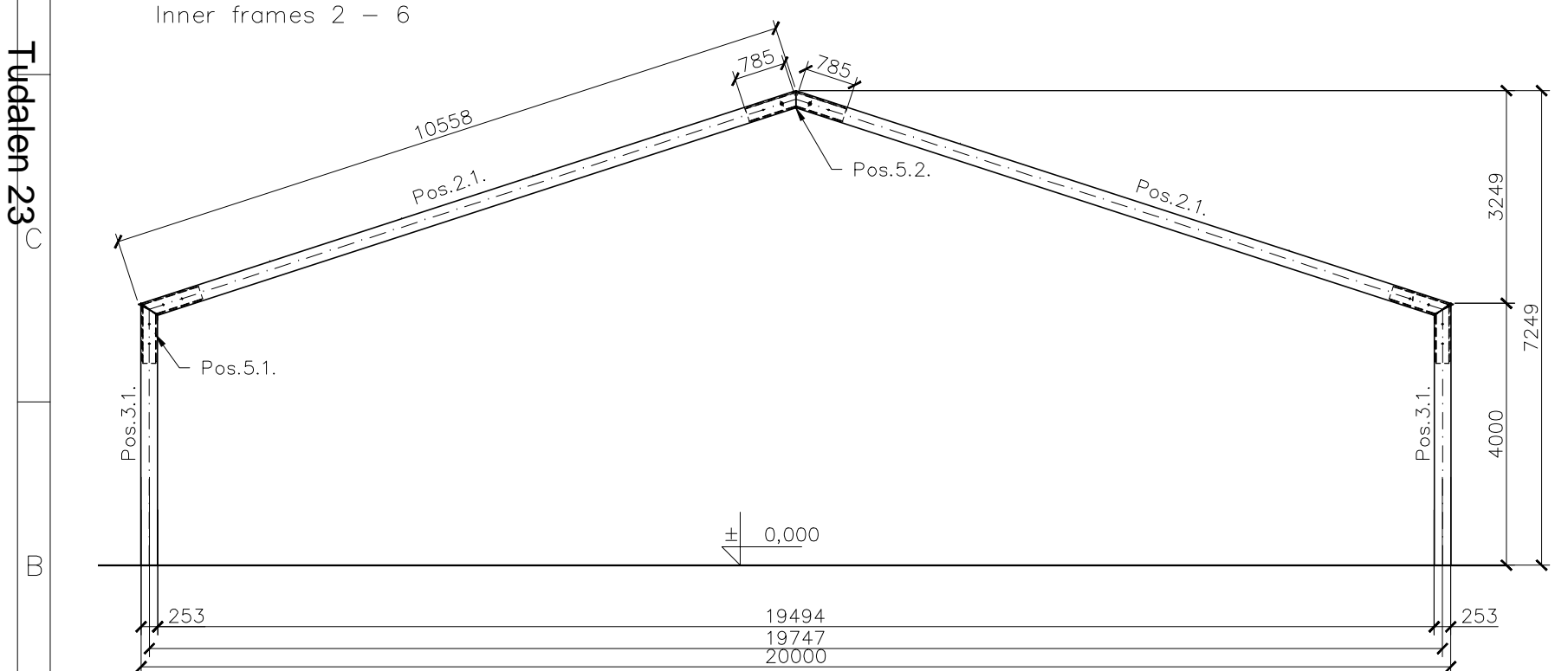
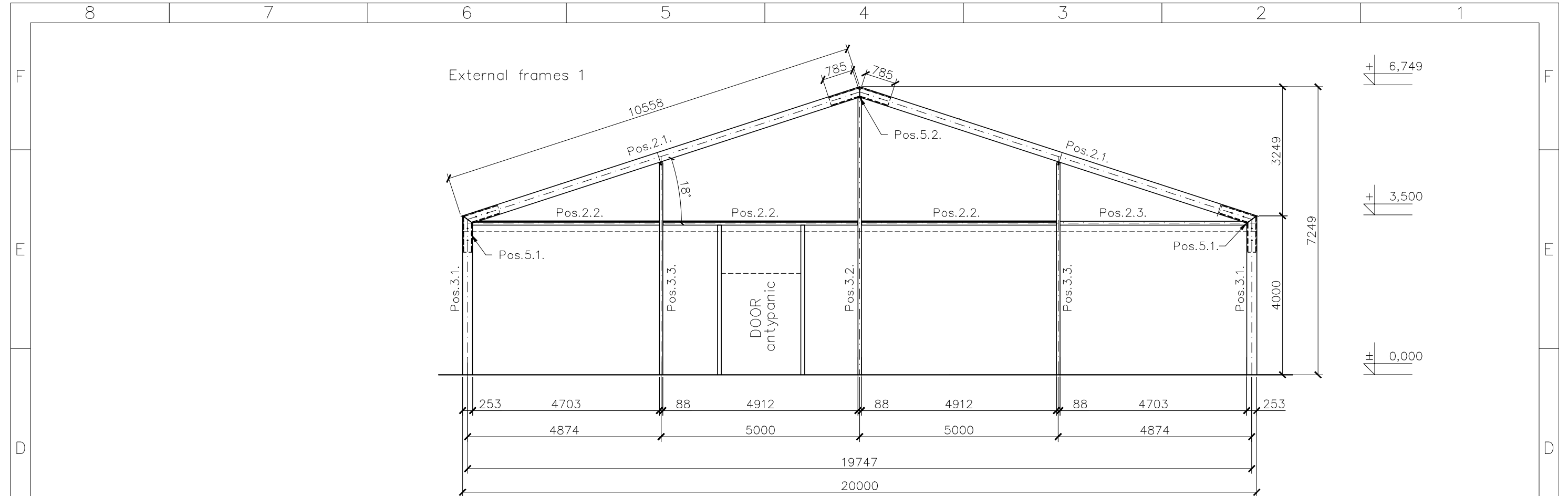

- Pos.1.1. Main purlin – Profile 105×105×3 mm – EN AW-6005A T6
- Pos.1.2. Secondary purlin – Profile 80×60×3 mm – EN AW-6061 T6
- Pos.1.3. Ridge purlin – Profile 100×80×3 mm – EN AW-6061 T6
- Pos.2.1. Roof beam – Profile 253×131×4,5 mm – EN AW-6061 T6
- Pos.2.2. Horizontal beam – Profile 105×105×3 mm – EN AW-6005A T6
- Pos.2.3. Horizontal beam roller shutter – Profile 150×100×3 mm – EN AW-6005A T6
- Pos.3.1. Main column – Profile 253×131×4,5 mm – EN AW-6061 T6
- Pos.3.2. Secondary column – Profile 170×88×3 mm – EN AW-6061 T6
- Pos.3.3. Secondary column – Profile 170×88×3 mm – EN AW-6061 T6
- Pos.3.4. Profile for trapezoid sheet T35 – Profile 60×60×3 mm – steel S235
- Pos.4. Cable bracings – Galvanised wire rope with minimum breaking load 1770 MPa 6×37+FC acc. to EN 12385-4, diameter 10 mm with turnbuckle CM-50-00 M20 and shackle CM-SP-1. Design capacity

PN-EN 1090-2 EXC2

Benedykt i Rafał Bródka "POL – PLAN"
 Zakład Produkcji Plandek Spółka Jawna
 ul. Wrocławska 42/44 62-060 Stęszew/Zamysławo
 C:\POL-PLAN.tif

| | | | |
|----------------------|------------------|---|---------------|
| INVESTOR: MARK JONES | | | |
| SUBJECT: | | Project design of tent hall with span 20.0m length 30.0m side wall height 3.0m and bay distance 5.0m —kopia | |
| | First Name, Name | Certificate no. | Signature |
| DRAWN: | | | |
| DESIGNER: | | | |
| DRAWING TITLE: | Frame view | Drg. No.: | Scale: Date: |
| | | 004 | 1:100 03-2020 |

Bistre youth and community centre
Roller shutter security doors installed.
Side elevation from car park.

Side Elevation
double door entrance

Tudalen 24

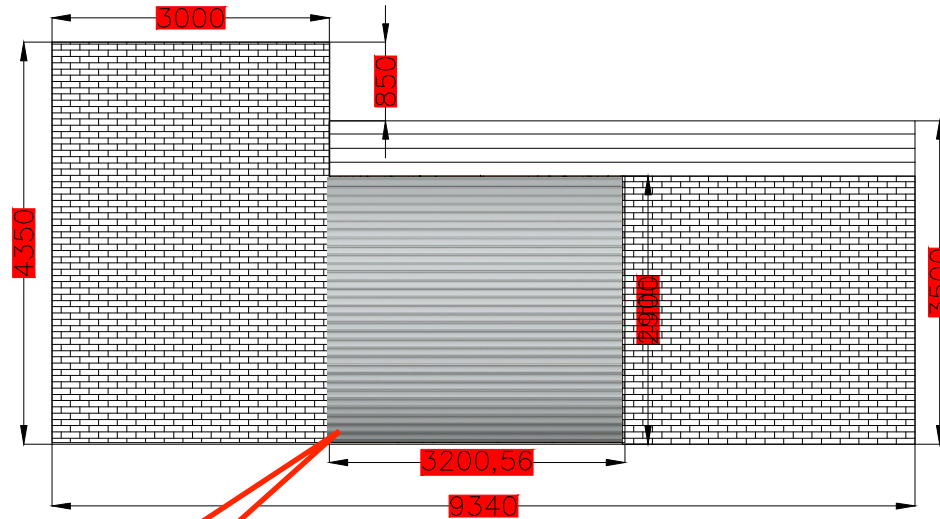

front of building
from car park end

Security doors
installed

Side Elevation
single door entrance

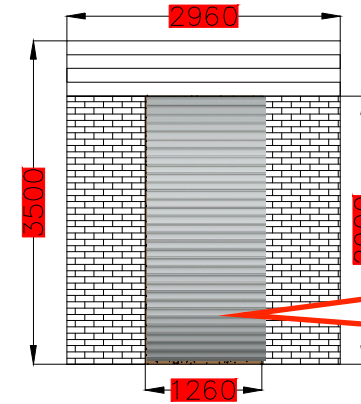

front of building
from car park end

Security doors
installed

Statement from Local Ward Member

Ref 061148

Bistre Community Centre Nant Mawr Road Buckley CH72PX

I have had a number of residents contact me with concerns about the covered training facility. Their main concern is that with these facilities there is always a lot of noise and because of the construction of the building the sound will echo and amplify. There will be coaches shouting instructions, whistles blowing, children shouting and cheering, and balls bouncing on the hard surface or off the walls, which will have the same effect as hitting a drum skin. They also feel that with the noise going on until 9pm any young children that go to bed before that time will be disturbed.

Consideration must also be given to the Bistre Scouts, they have 90 members, a mix of male and female ranging from 6 - 18 years and they were founded in 1975. The Scout hut was opened by Lord Barry Jones in 1982. The land that the hut is on is leased from FCC and is adjoining the land of the planning application. At the moment the parents of the Scouts park at the Community Centre, but this will not be possible with the proposed facility. Thus causing congestion on an already busy road.

I would like to request that the committee consider these concerns when discussing this planning application.

Kind Regards

Statement from Local Resident - objection

Site Address: Bistre Community Centre Nant Mawr Road Buckley
Objector

We wish to object to the planning proposal on the following points:

1. Traffic impact - increased noise and safety the existing entrance insufficient for traffic usage compromising pedestrian safety
2. Increase in noise and air pollution loss of greenspace and established greenery and wildlife
3. Pathway – the designated pathway at the rear of the building will impact on the privacy of residents as trees will have to be removed which were donated by the forestry commission to the local children
4. New build sports hall eyesore and not in-keeping with a residential area and noise pollution
5. Light pollution from all the floodlights from all weather pitch
6. Bakery – noise and smell from extractor fans. What benefit to the local economy?
7. Cafe – is there any real need as Buckley already have 4 again increase in traffic
8. New undercover area could provide a meeting point and encourage antisocial behaviour
9. Cub/Scouts have been using the car park and land for the last 46 years and where will the 90+ members park?
10. Proposed opening hours seem excessive and the effect on night worker
11. We have already got 3 established sports centres within a 3 mile radius
12. Wealth divide only available to people who can afford to pay so no benefit to local community

All the above points will have a detrimental effect on our daily lives if this could please be taken into consideration.

Applicant Statement

Notes: Bistre Community Centre Planning application.

Background.

Over the last two years we have worked tirelessly to bring to reality the vision which is based on the investing in the local community, of all ages, to bring back to life a community facility.

We have consulted with all key stakeholders and have sought to address concerns:

i) Car parking : additional car parking capacity is required. This has been done by utilising the disused play yard, creating an additional 30 spaces.

ii) Location of the indoor training facility.

The intention is to provide 52 a week training provision. This is only possible with an indoor training centre.

Following feedback, the location of the proposed indoor facility has changed, where there is less impact on residential properties, and distanced from the nearest residence is in line with FCC guidelines and planning policy.

iii) Noise pollution

The indoor training facility will close at 9pm. The noise impact report, shows that the impact will be negligible, mitigated by the location of the indoor facility and its building specification.

Within the existing building, there will be a bakery training facility, and new community café.

All current community use of the building will continue, with the aim to expand the community use. We hope that you will agree that this application will enhance and increase the facilities for the local community. We are passionate about the impact of community spirit and believe even more than ever in the benefits that it can bring to everyone.

Mae'r dudalen hon yn wag yn bwrpasol

Eitem ar gyfer y Rhaglen 6.2

FLINTSHIRE COUNTY COUNCIL

REPORT TO: **PLANNING COMMITTEE**

DATE: **WEDNESDAY, 31 MARCH 2021**

REPORT BY: **CHIEF OFFICER (PLANNING,
ENVIRONMENT AND ECONOMY)**

SUBJECT: **061974 - FULL APPLICATION -
RETENTION OF RESIDENTIAL
DWELLING AS BUILT AND
PROPOSED COMPLETION OF
DWELLING AT PEN UCHAF FARM,
PEN Y CEFN ROAD, CAERWYS,
MOLD**

APPLICATION NUMBER: **061974**

APPLICANT: **Mr Luke Francis**

SITE: **Pen Uchaf Farm,
Pen Y Cefn Road,
Caerwys,
Mold,
Flintshire
CH7 5BH**

**APPLICATION VALID
DATE:** **26th October 2020**

LOCAL MEMBER: **Councillor T Jones.**

**TOWN/COMMUNITY
COUNCIL:** **Caerwys Town Council.**

**REASON FOR
COMMITTEE:** **Local Member Request - Supports
Application. In that it will visually
improve the area; not be isolated
development; provide a local family
with a home; and its location is a
sustainable development.**

SITE VISIT: **No.**

1.00 SUMMARY

1.01 This application is for the retention of a new residential dwelling at Pen Uchaf Farm Barn, Pen Y Cefn Road, Caerwys.

2.00 RECOMMENDATION: TO REFUSE PLANNING PERMISSION FOR THE FOLLOWING REASONS

1. The Local Planning Authority considers that the proposals would be tantamount to the erection of a new dwelling in the open countryside, where there is a general presumption against unjustified development of this nature. Accordingly, the proposals are considered to be contrary to policies STR1,STR4, GEN3 and HSG4 of the Flintshire Unitary Development Plan.
2. It would lead to a sporadic form of development within the open countryside and within this part of The Clwydian Range and Dee Valley Area of Outstanding Natural Beauty, giving rise to a significant adverse impact upon the character and appearance of the area, thereby not maintaining and enhancing its natural beauty nor preserving its natural tranquillity. The proposals are therefore contrary to policies GEN1, D2 and L2 of the Flintshire Unitary Development Plan.
3. The proposals represent a form of development which is does not amount to sustainable development and, given its location distant from suitable public transport and local services, is therefore contrary to the principles which are the basis for the guidance contained within Planning Policy Wales Edition 11 February 2021 and would also be contrary to the requirements of Policies STR1 and GEN1 of the Flintshire Unitary Development Plan.

3.00 CONSULTATIONS.

3.01 Local Member

Councillor T Jones:

Requests Committee determination and supports the proposal on the following summarised grounds:

- Photographic record shows the whole building has not been demolished. A substantial part of the original building remains. Ruin has blighted this rural site for many decades. The development will blight the area for years to come.
- The JAC of the AONB do not object to the granting of planning permission.

- The proposal would not lead to an isolated form of development given that there is a dwelling opposite the barn and a further 18 dwellings within a radius of less than 1000m. The development of this property does not add any additional footprint to the countryside. It is also very close to the very large Maes Mynan Holiday Park.
- It will provide a home for a young local family which the community is in need of.
- The development is sustainable given that there are daily bus services from Caerwys to Holywell, Denbigh and Mold and the experimental bus service has operated in this area for approx. 2 years servicing the rural nature of the area. There is a proposed dial a ride service. Nearest virtual bus stop proposed is 3200m away. Such a distance is within normal walking distance. Barlow's Caravan Site provides a retail outlet for those residents in the surrounding Pen Y Cefn and Plas Pen Ucha area.

Caerwys Town Council:

Subject to compliance with the Development Plan, no objections raised.

Highways Development Control

Recommends that any permission to include a suggested condition in relation to the provisions of parking and turning facilities.

Community and Business Protection

No adverse comments to make.

Dwr Cymru Welsh Water:

As the applicant intends utilising a private treatment works, advise the applicant contacts NRW who may have an input into in the regulation

Natural Resources Wales:

Do not consider that the proposed development affects a matter listed in their Consultation Topics.

Clwyd- Powys Archaeological Trust:

Have been in touch with the applicant who has explained that the barn collapsed before a full photographic survey could be undertaken. In this case, have advised that they will accept the submitted images on the basis that this is all that is available.

Clwydian Range and Dee Valley AONB Joint Committee:

Submitted observations are summarised below as being:

- Disappointed that the original building has had to be demolished and a new replacement dwelling is under

construction. Providing the replacement dwelling replicates the character and appearance of the original building and approved scheme of conversion, no objection in principle to the proposals.

- Suggests that the traditional painted timber windows, doors and cast iron or aluminium rainwater goods would better reflect the traditional character of the building in place of the proposed UPVC units. New stonework should be traditionally finished local stone and facing brick of the shippon extension should be carefully selected reclaimed local brick to reflect the building's original character. No details of external lighting are shown, but recommends a condition requiring submission of further details of any external lighting to ensure it is designed and specified to conserve the AONB's dark sky and nocturnal wildlife.
- Recommends that the new residential curtilage should be enclosed with a traditional hedge comprising native local species and selected trees to help integrate the new dwelling into its rural setting. Permitted development rights should also be withdrawn.

SP Energy Networks:

Have plant and apparatus in the vicinity of the site. Applicant be advised of this.

Airbus:

No aerodrome safeguarding objection to the proposal.

4.00 PUBLICITY

4.01 Press Notice, Site, Notice, Neighbour Notification:

No responses received to date.

5.00 SITE HISTORY

5.01 **057125**

Conversion of an existing redundant stone barn and rebuilding of existing brick shippon into a single dwelling.
Granted 4th August 2017.

056751

Change of use of redundant agricultural barn into a single dwelling.
Withdrawn 17th May 2017.

054118

Application for a Prior Notification for the erection of a portal framed agricultural building.
Prior Approval Not Required 25th August 2015.

054035

Application for prior notification of proposed telecommunications development

Granted 1st September 2015.

98/01299

Cellnet Installation

Granted 14th December 1998.

6.00 PLANNING POLICIES

6.01 Flintshire Unitary Development Plan:

Policy STR1 New Development.

Policy STR4 Housing.

Policy GEN1 General Requirements for Development.

Policy GEN3 Development in the Open Countryside.

Policy D1 Design Quality, Location and Layout.

Policy D2 Design.

Policy D3 Landscaping.

Policy D4 Outdoor Lighting.

Policy L1 Landscape Character.

Policy L2 Area of Outstanding Natural Beauty.

Policy HE7 Other Sites of Lesser Archaeological Significance.

Policy HE8 Recording of Historic Features.

Policy HSG4 New Dwellings Outside Settlement Limits.

Policy HSG7 Change of Use to Residential Outside Settlement Boundaries.

Policy AC13 Access and Traffic Impact.

Policy EWP12 Pollution.

Supplementary Planning Guidance Notes

SPGN No.3 Landscaping.

SPGN No.4 Trees and Development.

SPGN No.5 Conversion of Rural Dwellings.

SPGN No.10 New Housing in the Open Countryside.

SPGN No.11 Parking Standards.

SPGN No.27 Archaeology.

National Planning Policy & Guidance:

Planning Policy Wales Edition 11 February 2021.

Technical Advice Note 6 - Planning for Sustainable Rural Communities (2010).

Technical Advice Note (TAN) 12: Design (2016).

7.00 PLANNING APPRAISAL

7.01 **The Site**

The site did comprise the former limestone wall and natural slate roof barn, attached brick built shippon and part hardstanding yard area of Pen Uchaf Barn, Pen Y Cefn Road, Caerwys.

- 7.02 The site is in the open countryside and Area of Outstanding Natural Beauty and is surrounded by pastureland interspersed with hedges and trees with Pen Y Cefn Road being narrow, single width, unlit and without pavements.
- 7.03 The nearest settlement of Caerwys is located approximately 1400m away to the East, which has a limited range of services, facilities and employment opportunities.
- 7.04 The towns of Holywell and Denbigh which are considered to offer a more substantial range of services, facilities and employment facilities lie approx. 8km to the North East and approx. 8km to the South West of the site respectively

The Proposal

- 7.05 The application is retrospective for the retention of works and continuation of development in connection with the erection a new dwellinghouse.
- 7.06 The proposals involve the retention of the existing walling of the structures already built, their completion together with their roofs to form a detached, two storey with an attached single storey extension (the former shippon), to form a four bedroom dwelling. The dwelling when completed will measure approx. 24m x 6m x 8.5m (height to ridge) and constructed within limestone walls and a natural slate roof. The element of the new dwelling in the position of the former attached brick shippon, when completed will measure approx. 13m x 6m x 4.3m (height to ridge) and constructed within red brick walls with a natural slate roof.

Background

- 7.07 The site has a background which is significant for members to be aware of.
- 7.08 Planning permission reference 057125 was granted on 4th August 2017 under delegated powers for conversion of an existing redundant stone barn and rebuilding of the attached into a single dwelling.
- 7.09 This application was determined using relevant Unitary Development Plan (UDP) Policy HSG7. This policy relates to the change of use to residential outside settlement boundaries. There are a number of criteria which are relevant to Policy HSG7 and the proposal at that time meet criteria a) as the building has been advertised for some time for use without success. The proposal also met the secondary criteria that the building was structurally sound and capable of conversion without extensive rebuilding.
- 7.10 In 2019 a planning enforcement complaint was received. This was investigated. Please see pictures Env SV 1 Pics 1 – 7 which demonstrate what was on site at 25th September 2019 date when the

site was first visited. The applicant was advised to cease works at this time. The site was visited again on 10th October 2019 and photos Enf SV 2 PIC.1 to 11 inclusive illustrate that works were continuing. Accordingly the Council served a Planning Contravention Notice seeking information in relation to the breach of planning control at the site.

7.11 As has been established from the investigation and as clearly indicated upon the photographs referenced above, that the barn had been demolished entirely and rebuilt to what is now in situ (see pictures SV 1- 7 inclusive).

7.12 The occupier was not invited to submit a planning application, but nonetheless, choose to submit an application in an attempt to regularise the unlawful works.

Main Issues

7.13 As the barn no longer exists this application is for a new dwelling in the open countryside and as such Policy HSG4 is now relevant.

7.14 Therefore the main issues to be considered whether this development is acceptable in the open countryside and an Area of Outstanding Natural Beauty.

7.15 **Principle of Development**

The site is located outside of any settlement boundaries and within the open countryside as defined by the Flintshire Unitary Development Plan. Due to this location and the nature of the development being the erection of a new dwelling, policies STR1, GEN3 and HSG4 are applicable in this case. These policies together with national planning policy guidance, essentially restricts this form of development outside of settlement boundaries and within the open countryside.

7.16 STR1 is the strategic policy which directs all new development to within settlement boundaries, allocations, development zones and principle employment areas and will only be permitted outside these areas where it is essential to have an open countryside location. The policy aim is to ensure the development of sustainable communities, high quality design and minimize adverse impacts on the physical, social and environment of the area. The proposals are located outside of all the areas referred to above and is therefore clearly contrary to this policy.

7.17 GEN3 advises that outside settlement boundaries or other development allocations and designations, land is considered as being in the 'open countryside' and because of the need to protect the countryside from unsustainable development, new development in general will not be permitted, unless the development falls into a category contained in a list of 10 exceptions. The proposal does not

comply with any of the exceptions identified in (a) to (j) accompanying Policy GEN3.

- 7.18 HSG4 states that new dwellings outside settlement boundaries will only be permitted where it is essential to house a farm or forestry worker who must live at or very close by to their place of work and not in a nearby dwelling or settlement. Neither the applicant nor the agent have stated that the dwelling is for such a purpose.
- 7.19 The above policies together with those Nationally in Planning Policy Wales Edition 11, place a strong emphasis on strictly controlling the development of new dwellings in the countryside away from existing settlements such as in this case. It is considered therefore that sporadic uncontrolled development such as this in the open countryside would destroy its rural character and therefore, only limited exceptions will be permitted.
- 7.20 Therefore, the development may only be permitted in very specific circumstances. The applicant nor the agent have not provided any justification for this dwelling to accord with the exceptions allowed.
- 7.21 Planning Policy Wales Edition 11 and Policy GEN3 of the Adopted Flintshire Unitary Development Plan requires that development of sites in the open countryside must only be considered in exceptional circumstances. PPW goes onto discuss that development should be located within existing urban areas or areas which are, or can be, easily reached by walking or cycling, and are well served by public transport.
- 7.22 It is considered that the site is poorly linked to the limited services available at the nearby settlement of Caerwys in terms of safe accessible pedestrian routes and the absence of easily accessible public transport links within the vicinity of the site.
- 7.23 Accordingly, as a matter of policy principle, the proposal to erect a new dwelling in the open countryside is contrary to both the national and local planning policies, as referenced above and is therefore unacceptable in policy terms.
- 7.24 Character and Appearance:
Members are advised that the original barn which stood on this site measured approx. 23m x 6m x 4.2m (height to ridge). The floor space of this building, including the brick shippon attached to the rear amounted to some 224.75m². The dwelling permitted to be formed via the conversion of this barn (permitted under Ref: 057125) measured 23m x 6m x 8m (height to ridge) and provided total floorplate, including the first floor to be created within the stone barn, of 354m². The proposals which are the subject of this application provided for a main part of the dwelling measuring approx. 24m x 6m x 8.5m (height to ridge) and providing a floor space of 375m².

- 7.25 The proposed development is considered to be large in size and scale, introducing a larger amount of built form than that previously considered acceptable via the conversion of the existing barn. It is also an unjustified form of development in the open countryside which is also within part of the Clwydian Range and Dee Valley Area of Outstanding Natural Beauty, with the site located in a particularly visible position alongside this Western side and brow of Pen Y Cefn Road.
- 7.26 Surrounding the site lies pastureland interspersed with hedgerows and trees. Opposite the site lies the two storey dwelling of Pen Uchaf. This in turn is surrounded by pastureland interspersed by hedgerows and trees.
- 7.27 Although the development would replace the buildings that were once upon site, given that they were demolished, in planning policy terms, the proposal constitutes a new dwelling in the open countryside with the added protection of it being located within part of The Clwydian Range and Dee Valley Area of Outstanding Natural Beauty whereby it needs also to maintain and where appropriate enhance the natural beauty, wildlife and cultural heritage and preserve the natural tranquillity of it. The barn was a traditional stone wall and slated building was typical of the vernacular of historic agricultural buildings in this rural area, the barn being one of many sitting in the wider landscape of the area.
- 7.28 As highlighted in paragraph at 7.24, the dwelling proposed in this application therefore represents the introduction of a larger amount of built form than that previously in existence on the site, or than that permitted to be created through conversion. As such it will appear as a visually discordant form of development within this landscape.
- 7.29 To conclude, therefore given the nature of the development in that it is a new unjustified dwelling in the open countryside and within part of the AONB, and positioned in a prominent location, it represents a form of sporadic development having a significant detrimental impact upon the character and appearance of the countryside which also does not maintain and enhance the natural and preserve the natural tranquillity of this part of The Clwydian Range and Dee Valley Area of Outstanding Natural Beauty.
- 7.30 Other Matters:
Whilst it is acknowledged that planning permission was granted for conversion of the dwelling, and the LPA has had regard to the fact that if implemented correctly by the applicant would have resulted in a dwelling, the conversion would have represented a sustainable form of development, being the re-use of an existing building and all of the resources contained therein compared to the wholly new build development proposed.

7.31 In terms of the comments made in support of the proposals by Councillor Jones, I advise as follows;

- 1) The pictures and evidence from the enforcement site visit referred to above and the admission from the applicant show that the building has been entirely demolished. Therefore the proposal is entirely a new development and not a re-use.
- 2) The comments from Natural Resources Wales are noted and have been weighed into the planning balance in making this recommendation.
- 3) The existing pattern of development is consistent with the character of the rural landscape. Policy HSG5 of the Flintshire Unitary Development Plan is the relevant policy that deals with infill development outside settlement boundaries. This states that;

Outside settlement boundaries infill development for one or two housing unit(s) may be permitted, provided that the proposal is to meet a proven local housing need and:

- a) comprises a small gap which is not an important landscape, nature conservation, historic or other amenity feature within a clearly identifiable small group of houses within a continuously developed frontage;*
- b) does not constitute, or extend existing, ribbon development which would be detrimental to the character and appearance of open countryside, and does not create fragmented development; and*
- c) respects adjacent properties and the surrounding area in terms of its siting, form, design and scale, and does not represent overdevelopment of the site.*

Neither the applicant nor the agent has not put forward any evidence to demonstrate that the proposal is to provide a proven local housing need.

The dwelling is situated upon its own on the western side of Pen Y Cefn Road and therefore does not comprise of a small gap of houses within a continuously developed frontage.

Its' position, being situated on its own therefore creates a fragmented development.

This proposal, by virtue of it being large in size and scale does not respect the adjacent original farmhouse opposite.

Given the above, the proposal does not comply with policy HSG5 and is not therefore infill development.

- 4) As stated above, no evidence has been put forward by the applicant or their agent to demonstrate how the proposal meets a local housing need. Indeed the nature and scale of the proposal i.e. a large, detached, four bedroomed dwelling is not representative of an affordable dwelling.
- 5) The development is not considered to be in a sustainable location given that the nearest settlement is Caerwys, which has a limited range of services, facilities etc and is only reached by narrow, unlit country roads which are devoid of pavements and any occupier would be largely dependent on the use of a private motor vehicle.

8.00 CONCLUSION

This proposal represents wholly unjustified residential development in the open countryside, contrary to National and local policy and no material considerations outweigh the strong established planning policy presumption against development of this form in locations such as this.

Other Considerations

- 8.01 The Council has had due regard to its duty under Section 17 of the Crime and Disorder Act 1998 and considered that there would be no significant or unacceptable increase in crime and disorder as a result of the recommended decision.
- 8.02 The Council has acted in accordance with the Human Rights Act 1998 including Article 8 of the Convention and in a manner which is necessary in a democratic society in furtherance of the legitimate aims of the Act and the Convention.
- 8.03 The Council has had due regard to its public sector equality duty under the Equality Act 2010.
- 8.04 The Council has had due regard to its duty under Section 3 of the Wellbeing of Future Generations (Wales) Act 2015 and considered that there would be no significant or unacceptable impact upon the achievement of wellbeing objectives as a result of the recommended decision.

LIST OF BACKGROUND DOCUMENTS

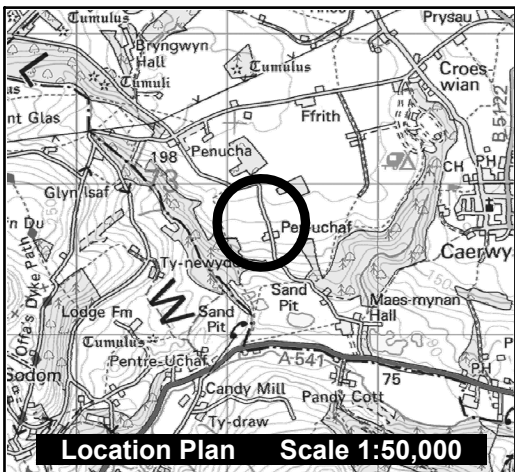
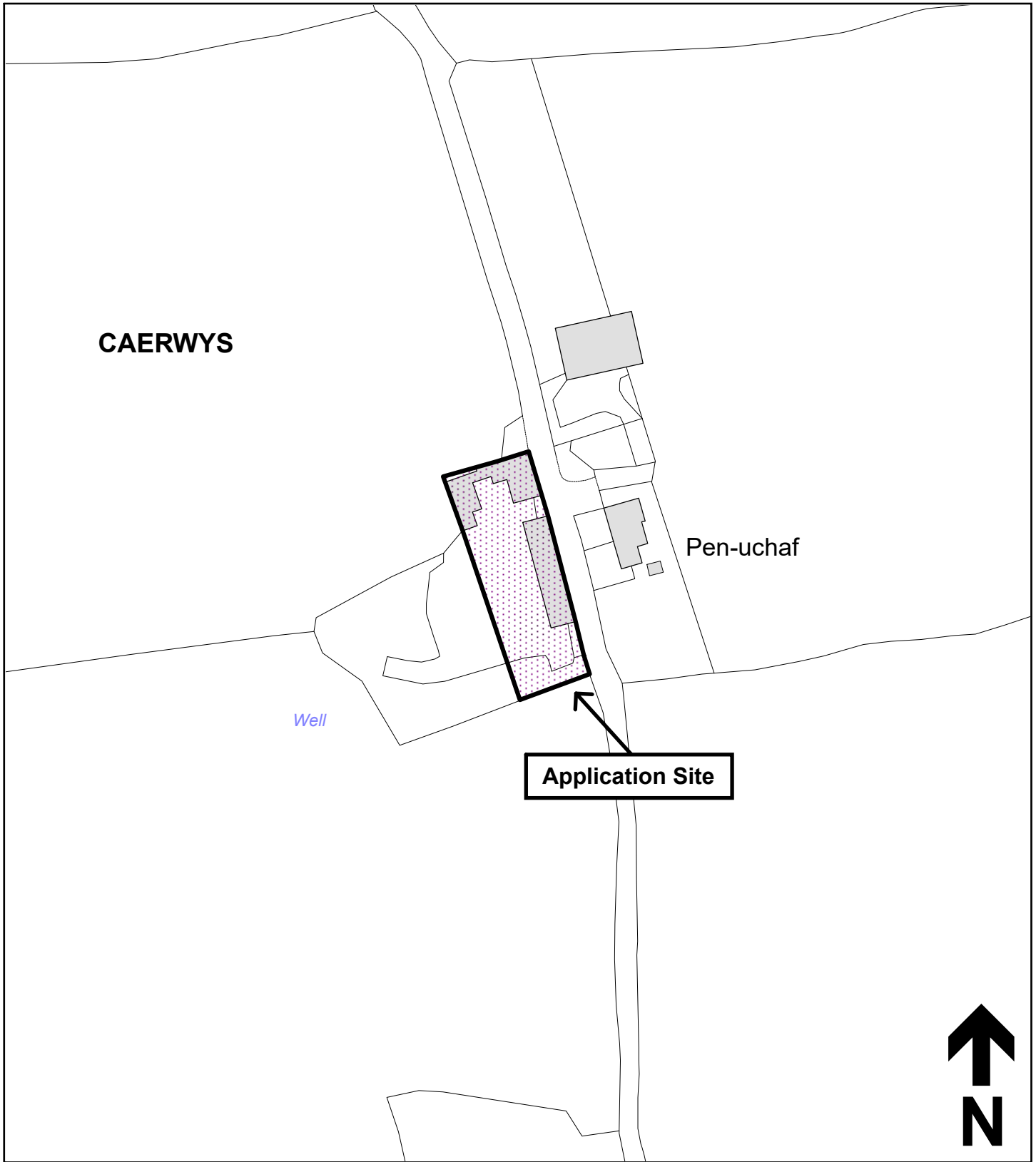

Planning Application & Supporting Documents
National & Local Planning Policy
Responses to Consultation
Responses to Publicity

Contact Officer: Alan Wells
Telephone: 01352 703255
Email: alan.wells@flintshire.gov.uk



 Planning, Environment & Economy,
 Flintshire County Council, County Hall,
 Mold, Flintshire, CH7 6NF.
 Chief Officer: Mr Andrew Farrow

Legend

-  Planning Application Site
-  Adopted Flintshire Unitary Development Plan Settlement Boundary

Tudalen 41

This plan is based on Ordnance Survey Material with the permission of the Controller of Her Majesty's Stationery Office. © Crown Copyright. Unauthorised reproduction infringes Crown Copyright and may lead to prosecution or civil proceedings. Licence number: 100023386. Flintshire County Council, 2021.

| | |
|----------------------|--------------|
| Map Scale | 1:1250 |
| OS Map ref | SJ 1172 |
| Planning Application | 61974 |

Tudalen 42

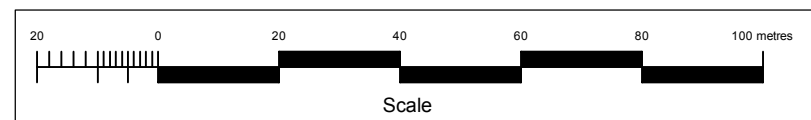
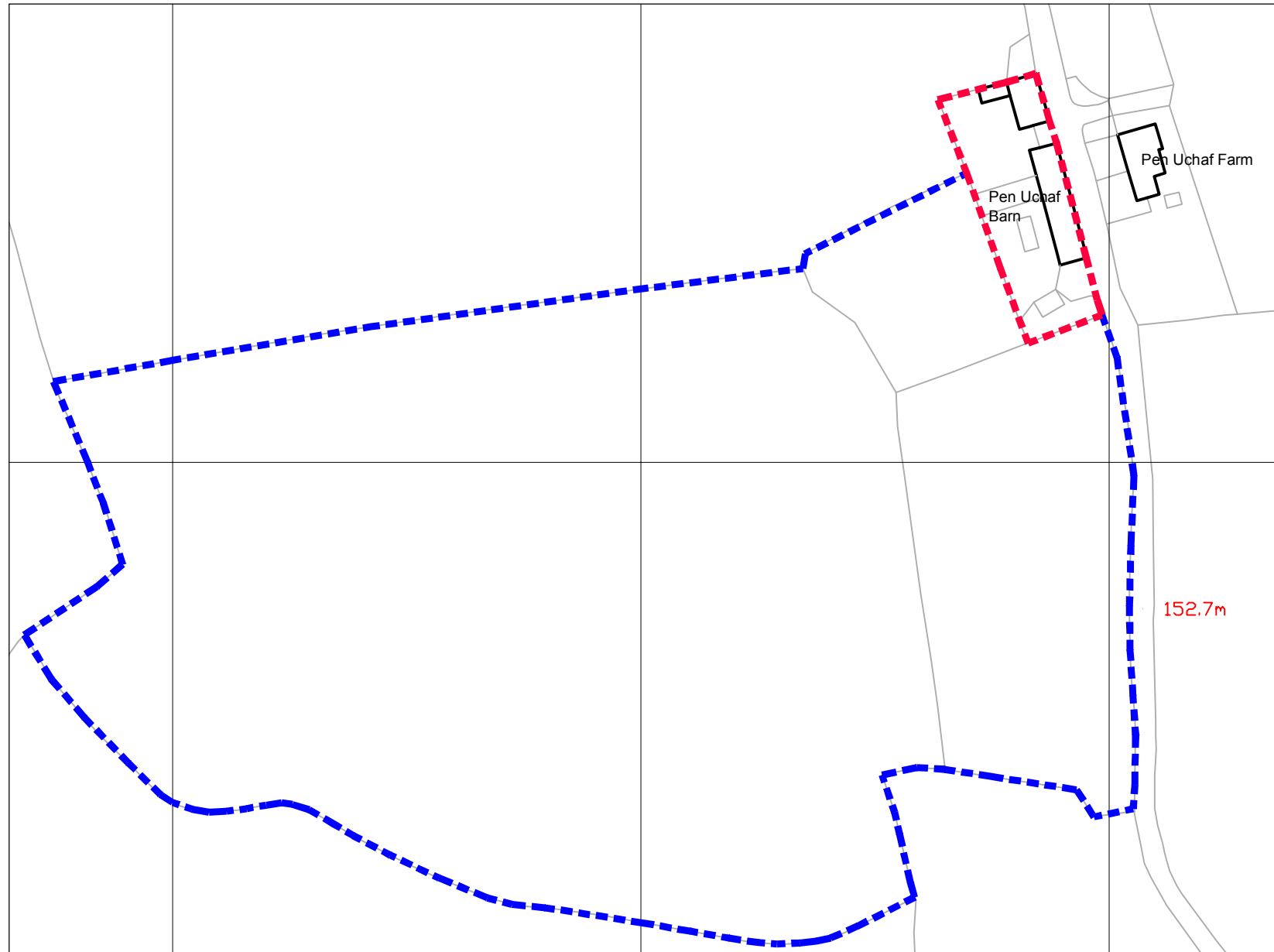

NOTES:-

THIS DRAWING IS THE COPYRIGHT OF THE ARCHITECT AND IS NOT TO BE REPRODUCED WITHOUT HIS PERMISSION.

THE CONTRACTOR IS RESPONSIBLE FOR CHECKING DIMENSIONS, TOLERANCES AND REFERENCES. ANY DISCREPANCIES TO BE CHECKED WITH THE ARCHITECT BEFORE PROCEEDING WITH THE WORKS. IF IN DOUBT - ASK.

DO NOT SCALE FROM THIS DRAWING. FIGURED DIMENSIONS TO BE WORKED TO AT ALL TIMES.

ALL WORK AND MATERIALS TO BE IN ACCORDANCE WITH THE LATEST EDITION OF THE BUILDING REGULATIONS AND TO COMPLY WITH THE RELEVANT CODES OF PRACTICE AND BRITISH STANDARDS.

ALL MATERIALS ARE TO BE FITTED AND INSTALLED STRICTLY IN ACCORDANCE WITH THE MANUFACTURERS SPECIFICATIONS AND RECOMMENDATIONS.

ALL SUBCONTRACTORS ARE TO SITE MEASURE PRIOR TO MANUFACTURING COMPONENTS FOR THE BUILDING. NO LIABILITY WILL BE ACCEPTED FOR ELEMENTS THAT DON'T FIT.



----- Land under the applicants ownership.

----- Application site boundary.

REPRODUCED FROM THE ORDNANCE SURVEY 1:1250 SUPERPLAN MAP WITH THE PERMISSION OF THE CONTROLLER OF HER MAJESTY'S STATIONERY OFFICE, CROWN COPYRIGHT. REPRODUCTION IS PROHIBITED. SERIAL NUMBER : 001460939.

| REVISION | DATE | DETAILS |
|--------------------|---|---------|
| client | Luke Francis | |
| project | Pen Uchaf Barn Pen y Cefn Road; Caerwys. | |
| date | August 2020 | |
| dwg. title | Location plan | |
| dwg. no. | 166 P 51 | |
| dwg. scale | 1:1250 @ A3 | |
| dwg. status | Planning | |

David McChesney Architect Ltd.

BA(Hons).Dip Arch. Dip Arch Practice. ARB.

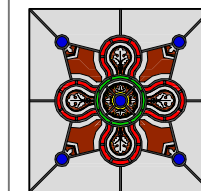

Pengwibnant
Mertyn Downing Lane
Whitford
Holywell
Flintshire
CH8 9EP
tel:01745 560904
email:david@dm-architect.co.uk

Tudalen 43

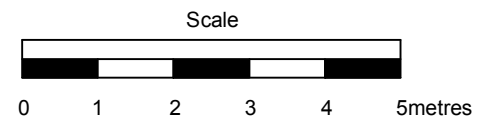
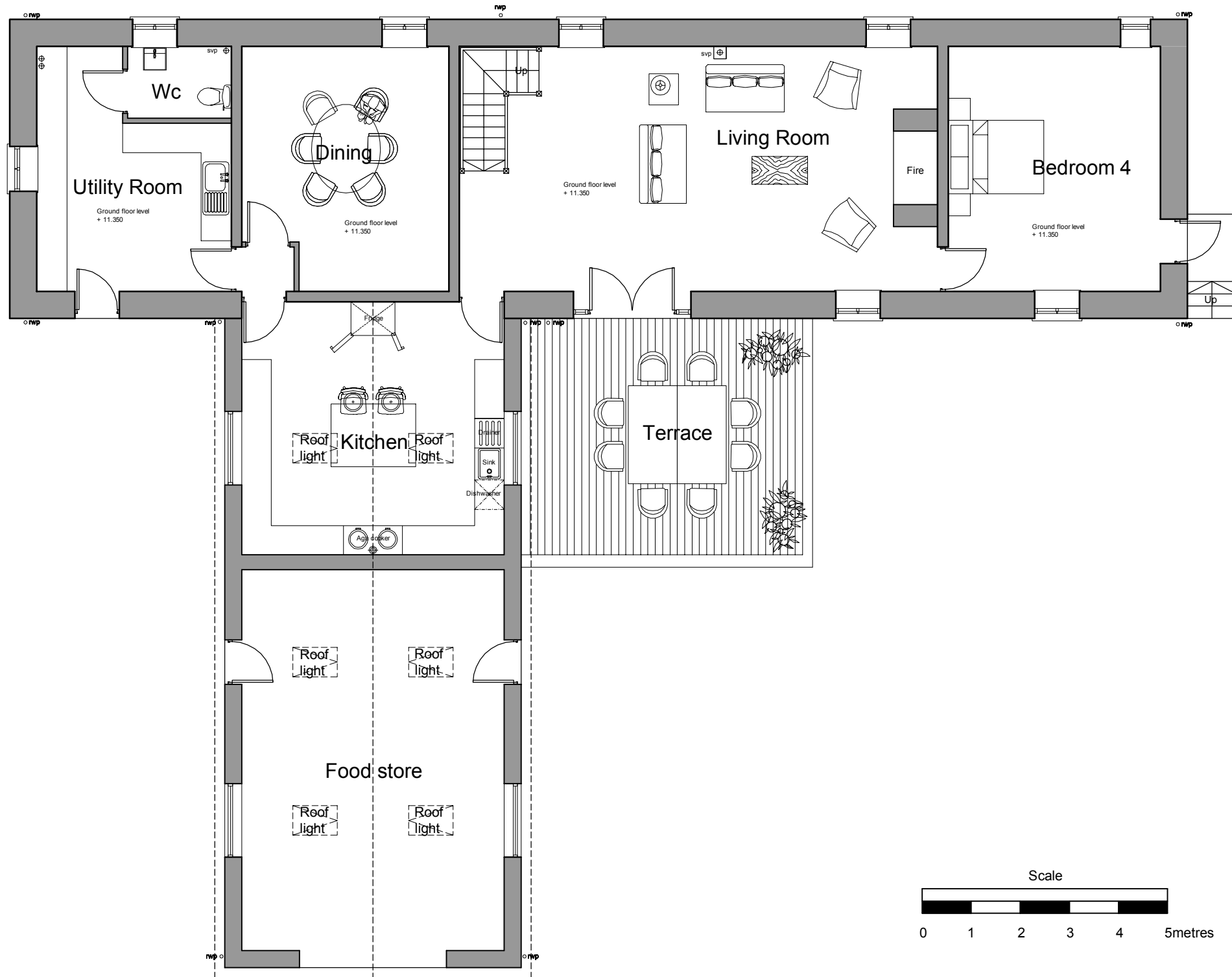

NOTES:-

THIS DRAWING IS THE COPYRIGHT OF THE ARCHITECT AND IS NOT TO BE REPRODUCED WITHOUT HIS PERMISSION.

THE CONTRACTOR IS RESPONSIBLE FOR CHECKING DIMENSIONS, TOLERANCES AND REFERENCES. ANY DISCREPANCIES TO BE CHECKED WITH THE ARCHITECT BEFORE PROCEEDING WITH THE WORKS. IF IN DOUBT - ASK.

DO NOT SCALE FROM THIS DRAWING. FIGURED DIMENSIONS TO BE WORKED TO AT ALL TIMES.

ALL WORK AND MATERIALS TO BE IN ACCORDANCE WITH THE LATEST EDITION OF THE BUILDING REGULATIONS AND TO COMPLY WITH THE RELEVANT CODES OF PRACTICE AND BRITISH STANDARDS.

ALL MATERIALS ARE TO BE FITTED AND INSTALLED STRICTLY IN ACCORDANCE WITH THE MANUFACTURERS SPECIFICATIONS AND RECOMMENDATIONS.

ALL SUBCONTRACTORS ARE TO SITE MEASURE PRIOR TO MANUFACTURING COMPONENTS FOR THE BUILDING. NO LIABILITY WILL BE ACCEPTED FOR ELEMENTS THAT DON'T FIT.

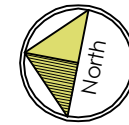

PROPOSED DRAWING

| REVISION | DATE | DETAILS |
|----------|------|---------|
| | | |
| | | |
| | | |
| | | |
| | | |
| | | |
| | | |
| | | |
| | | |

| | |
|--------------------|---|
| client | Luke Francis |
| project | Pen Uchaf Barn Pen y Cefn Road; Caerwys. |
| date | August 2020 |
| dwg. title | Proposed ground floor plan |
| dwg. no. | 166 P 59 |
| dwg. scale | 1:100@A3 |
| dwg. status | Planning |

David McChesney Architect Ltd.

BA(Hons).Dip Arch. Dip Arch Practice. ARB.

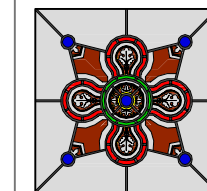

Pengwibnant
Mertyn Downing Lane
Whitford
Holywell
Flintshire
CH8 9EP
tel:01745 560904
email:david@dm-architect.co.uk

Statement from Applicant

Application reference number: ADW/061974 (Pen Uchaf Farm, Pen y Cefn Road, Caerwys)

Written Statement:

My wife and I are hoping to create a family home for ourselves and our 6 month old daughter. It is situated in the community we were brought up in, we are presently renting a room with family in Denbigh.

The stone barn and red brick shippon had been derelict for many decades. In 2017 we were granted planning permission ref 057125 to create our own home through conversion and re-build on the footprint of the derelict property.

Unfortunately Flintshire planning department failed to request a structural survey, the condition of the barn walls were in poorer condition than expected and parts collapsed as we removed a large tree/roots and vegetation.

We later discovered, having started to rebuild the walls, that we required permission to rebuild what had collapsed accidentally. As a consequence the planning department halted the work and later refused permission for us to continue in 2019. We managed to save one small part of the building and we kept to the exact plans and original footprint of the existing planning application granted in 2017.

Please can you consider a positive outcome for our application to allow us to create our family home which was originally given permission in 2017.

We have agreed to abide by the adjustments and agreements proposed by the planners and the Joint Committee of the AONB for this area.

Without permission the ruin will remain when it could be restored sympathetically with its original character and local stone/brick and become our family home.

Word count: 250

Statement from Local Ward Member

I seek the Planning Committee's support for the granting of this application and ask that you consider the positive observations made by the Joint Committee of AONB which offered suggestions for the use of materials to retain the original character of the former buildings.

Caerwys Town Council Members supported the original application (2017) and now support the present reapplication. They are, as I am, surprised that this reapplication presents any issues of contention.

The derelict barn and shippon are a blight on the countryside and an eyesore for the residents who live directly opposite. The ruin is also a site of potential danger for any inquisitive visitors to the area; of which there will soon be a great many, following Planning Committee's approval for the large holiday park at the previous Maes Mynan quarry just 500 metres away down the road.

The site is in ruins and the sympathetic redevelopment of the property; as accepted by Planning, for the original application in 2017, would heal this blighted wound in the countryside, create a useful property with the character of the original barn and shippon. This would be a significant improvement on what presently exists and what would remain, should the application be refused.

The contention by the Planning Department that this application is for a new dwelling makes little sense to me as there will be little change between what will be there and what was previously permitted to be there.

The rebuilt property will become a useful living home with much of the character of the original building. Replacing the ruin with this dwelling within the original footprint and retaining the character of the original stonework will enhance the area. It will occupy an otherwise untidy and potentially dangerous brownfield site with no loss of countryside.

I hope that the Members have been able to review my initial detailed submission to the Planning Department which addresses each of the four views offered for refusal. I have provided factual evidence and detailed local knowledge to challenge each of the points:

Describing as a new build (it is not), negative impact on the landscape (AONB say not), isolation from local services (all utilities exist / are accessible and there is a retail outlet within 3,000m,) and fourthly no access to public transport (This is an improving service with the proposed expansion of the Community Bus Service with its new virtual bus stops).

May I respectfully ask the Members to support this application.